



# Dell™ Studio XPS™ 1340 Service Manual

[Before You Begin](#)  
[Base Cover](#)  
[Coin-Cell Battery](#)  
[Hard Drive](#)  
[Memory](#)  
[Rear Caps](#)  
[Processor Heat Sink](#)  
[Processor](#)  
[Wireless Mini-Card](#)  
[Palm Rest](#)

[Keyboard](#)  
[Display Assembly](#)  
[Optical Drive](#)  
[Status Light Board](#)  
[System Board](#)  
[eSATA Connector](#)  
[AC Adapter Connector](#)  
[Battery Latch Assembly](#)  
[Flashing the BIOS](#)

---

## Notes, Notices, and Cautions

-  **NOTE:** A NOTE indicates important information that helps you make better use of your computer.
  -  **NOTICE:** A NOTICE indicates either potential damage to hardware or loss of data and tells you how to avoid the problem.
  -  **CAUTION:** A CAUTION indicates a potential for property damage, personal injury, or death.
- 

Information in this document is subject to change without notice.  
© 2008 Dell Inc. All rights reserved.

Reproduction of these materials in any manner whatsoever without the written permission of Dell Inc. is strictly forbidden.

Trademarks used in this text: *Dell*, *XPS*, and the *DELL* logo are trademarks of Dell Inc.; *Bluetooth* is a registered trademark owned by Bluetooth SIG, Inc. and is used by Dell under license; *Microsoft*, *Windows*, *Windows Vista*, and *Windows Vista start button logo* are either trademarks or registered trademarks of Microsoft Corporation in the United States and/or other countries.

Other trademarks and trade names may be used in this document to refer to either the entities claiming the marks and names or their products. Dell Inc. disclaims any proprietary interest in trademarks and trade names other than its own.

Model PP17S

December 2008 Rev. A00

## Base Cover

### Dell™ Studio XPS™ 1340 Service Manual

- [Removing the Base Cover](#)
- [Replacing the Base Cover](#)

- ⚠ **CAUTION:** Before working inside your computer, read the safety information that shipped with your computer. For additional safety best practices information, see the Regulatory Compliance Homepage at [www.dell.com/regulatory\\_compliance](http://www.dell.com/regulatory_compliance).
  - ⚠ **CAUTION:** Before performing these procedures, turn off the computer, disconnect the AC adapter from the electrical outlet and the computer, disconnect the modem from the wall connector and the computer, and remove any other external cables from the computer.
  - 🔒 **NOTICE:** To avoid electrostatic discharge, ground yourself by using a wrist grounding strap or by periodically touching an unpainted metal surface (such as a connector on the back of the computer).
  - 🔒 **NOTICE:** Only a certified service technician should perform repairs on your computer. Damage due to servicing that is not authorized by Dell™ is not covered by your warranty.
  - 🔒 **NOTICE:** To help prevent damage to the system board, remove the main battery (see [Before Working Inside Your Computer](#)) before working inside the computer.
- 

## Removing the Base Cover

1. Ensure that the computer is turned off.
2. Remove the battery (see [Before Working Inside Your Computer](#)).
3. Loosen the ten captive screws on the base cover and lift the cover off the computer.

- ⚠ **CAUTION:** Do not touch the processor heat sink. Processor components should be removed only by trained support personnel.

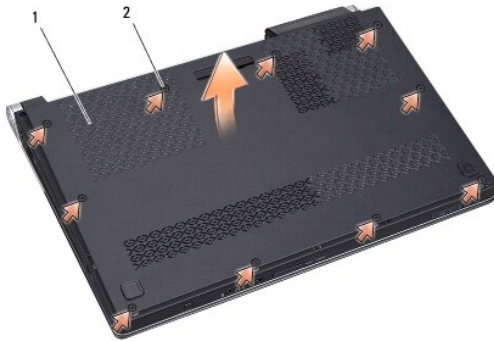

1	base cover	2	captive screws (10)
---	------------	---	---------------------

---

## Replacing the Base Cover

1. Replace the base cover.
  2. Tighten the ten captive screws on the base cover.
  3. Slide the battery into the battery bay until it clicks into place.
-

## Battery Latch Assembly

### Dell™ Studio XPS™ 1340 Service Manual

- [Removing the Battery Latch Assembly](#)
- [Replacing the Battery Latch Assembly](#)

- ⚠ CAUTION:** Before working inside your computer, read the safety information that shipped with your computer. For additional safety best practices information, see the Regulatory Compliance Homepage at [www.dell.com/regulatory\\_compliance](http://www.dell.com/regulatory_compliance).
- ➡ **NOTICE:** To avoid electrostatic discharge, ground yourself by using a wrist grounding strap or by periodically touching an unpainted metal surface (such as the back panel) on the computer.
- ➡ **NOTICE:** Only a certified service technician should perform repairs on your computer. Damage due to servicing that is not authorized by Dell™ is not covered by your warranty.
- ➡ **NOTICE:** To help prevent damage to the system board, remove the main battery (see [Before Working Inside Your Computer](#)) before working inside the computer.
- 

## Removing the Battery Latch Assembly

1. Follow the instructions in [Before Working Inside Your Computer](#).
2. Remove the system board (see [Removing the System Board](#)).
3. Remove the mylar tapes on both ends of the battery latch assembly.

**🔧 NOTE:** The mylar tapes are fragile. Remove them carefully. You may have to reuse the tapes while replacing the battery latch assembly.

4. Squeeze the battery release latch clip to remove the battery release latch.
5. Remove the spring from the hook that holds it in place.
6. Lift the battery latch assembly out of the computer base.

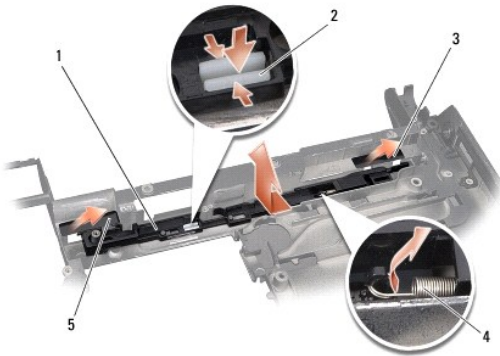

1	battery latch assembly	2	battery release latch clip
3	right mylar tape	4	spring
5	left mylar tape		

---

## Replacing the Battery Latch Assembly

1. Place the battery latch assembly in the channel in the computer base.
2. Push the battery release latch clip into the computer base.
3. Using a small screwdriver, place the spring over the hook on the computer base.

4. Replace the mylar tapes.

Ensure that the newly installed latch moves smoothly and freely when pushed and released.

5. Follow the instructions in [Replacing the System Board](#).

 **NOTICE:** Before turning on the computer, replace all screws and ensure that no stray screws remain inside the computer. Failure to do so may result in damage to the computer.

---

[Back to Contents Page](#)

[Back to Contents Page](#)

## Before You Begin

### Dell™ Studio XPS™ 1340 Service Manual

- [Recommended Tools](#)
- [Turning Off Your Computer](#)
- [Before Working Inside Your Computer](#)

This section provides procedures for removing and installing the components in your computer. Unless otherwise noted, each procedure assumes that the following conditions exist:

- 1 You have performed the steps in [Turning Off Your Computer](#) and [Before Working Inside Your Computer](#).
- 1 You have read the safety information that shipped with your computer.
- 1 A component can be replaced or—if purchased separately—installed by performing the removal procedure in reverse order.

---

## Recommended Tools



The procedures in this document may require the following tools:

- 1 Phillips screwdriver
- 1 Processor extraction tool
- 1 Small flat-blade screwdriver
- 1 Torx T5 screwdriver
- 1 BIOS upgrade CD

---

## Turning Off Your Computer





 **NOTICE:** To avoid losing data, save and close all open files and exit all open programs before you turn off your computer.

1. Save and close all open files and exit all open programs.
2. In Microsoft® Windows Vista®, click **Start** , click the arrow , and then click **Shut Down**.  
  
The computer turns off after the operating system shutdown process finishes.
3. Ensure that the computer and any attached devices are turned off. If your computer and attached devices did not automatically turn off when you shut down your operating system, press and hold the power button for at least 8 to 10 seconds until the computer turns off.

---

## Before Working Inside Your Computer

Use the following safety guidelines to help protect your computer from potential damage and to help to ensure your own personal safety.

-  **CAUTION:** Before working inside your computer, read the safety information that shipped with your computer. For additional safety best practices information, see the Regulatory Compliance Homepage at [www.dell.com/regulatory\\_compliance](http://www.dell.com/regulatory_compliance).
-  **NOTICE:** Handle components and cards with care. Do not touch the components or contacts on a card. Hold a card by its edges. Hold a component such as a processor by its edges, not by its pins.
-  **NOTICE:** Only a certified service technician should perform repairs on your computer. Damage due to servicing that is not authorized by Dell is not covered by your warranty.
-  **NOTICE:** When you disconnect a cable, pull on its connector or on its pull-tab, not on the cable itself. Some cables have connectors with locking tabs; if you are disconnecting this type of cable, press in on the locking tabs before you disconnect the cable. As you pull connectors apart, keep them evenly aligned to avoid bending any connector pins. Also, before you connect a cable, ensure that both connectors are correctly oriented and aligned.
-  **NOTICE:** To avoid damaging the computer, perform the following steps before you begin working inside the computer.
  1. Ensure that the work surface is flat and clean to prevent the computer cover from being scratched.

2. Turn off your computer (see [Turning Off Your Computer](#)).

🔗 **NOTICE:** To disconnect a network cable, first unplug the cable from your computer and then unplug the cable from the network device.

3. Disconnect all telephone or network cables from the computer.

4. Press and eject any installed cards from the ExpressCard slot and the 8-in--1 Memory Card Reader.

5. Disconnect your computer and all attached devices from their electrical outlets.

🔗 **NOTICE:** To help prevent damage to the system board, you must remove the battery from the battery bay before you service the computer.

🔗 **NOTICE:** To avoid damage to the computer, use only the battery designed for this particular Dell computer. Do not use batteries designed for other Dell computers.

6. Turn the computer over.

7. Slide the battery release latch to the side.

8. Slide the battery out of the battery bay.



1	battery	2	battery release latch
---	---------	---	-----------------------

9. Press the power button to ground the system board.

---

[Back to Contents Page](#)

## Flashing the BIOS

### Dell™ Studio XPS™ 1340 Service Manual

- [Flashing the BIOS From a CD](#)
- [Flashing the BIOS From the Hard Drive](#)

If a BIOS upgrade CD is provided with the new system board, flash the BIOS from the CD. If you do not have a BIOS upgrade CD, flash the BIOS from the hard drive.

---

### Flashing the BIOS From a CD

1. Ensure that the AC adapter is plugged in and that the main battery is installed properly.

 **NOTE:** If you use a BIOS upgrade CD to flash the BIOS, set up the computer to boot from a CD before inserting the CD.

2. Insert the BIOS upgrade CD, and restart the computer.

Follow the instructions that appear on the screen. The computer continues to boot and updates the new BIOS. When the flash update is complete, the computer will automatically reboot.

3. Press <F2> during POST to enter the system setup program.
  4. Select the **Exit menu**.
  5. **Select Load Setup Defaults** to reset the computer defaults.
  6. Remove the BIOS upgrade CD from the drive.
  7. Select **Exit Saving Changes** to save configuration changes.
  8. The BIOS upgrade finishes and the computer restarts automatically.
- 

### Flashing the BIOS From the Hard Drive

1. Ensure that the AC adapter is plugged in, the main battery is properly installed, and a network cable is attached.
  2. Turn on the computer.
  3. Locate the latest BIOS update file for your computer at [support.dell.com](http://support.dell.com).
  4. Click **Download Now** to download the file.
  5. If the **Export Compliance Disclaimer** window appears, click **Yes, I Accept this Agreement**.  
The **File Download** window appears.
  6. Click **Save this program to disk** and then click **OK**.  
The **Save In** window appears.
  7. Click the down arrow to view the **Save In** menu, select **Desktop**, and then click **Save**.  
The file downloads to your desktop.
  8. Click **Close** if the **Download Complete** window appears.  
The file icon appears on your desktop and is titled the same as the downloaded BIOS update file.
  9. Double-click the file icon on the desktop and follow the instructions on the screen.
-





[Back to Contents Page](#)

## Coin-Cell Battery

Dell™ Studio XPS™ 1340 Service Manual

- [Removing the Coin-Cell Battery](#)
- [Replacing the Coin-Cell Battery](#)

- ⚠ CAUTION:** Before working inside your computer, read the safety information that shipped with your computer. For additional safety best practices information, see the Regulatory Compliance Homepage at [www.dell.com/regulatory\\_compliance](http://www.dell.com/regulatory_compliance).
- ➡ NOTICE:** To avoid electrostatic discharge, ground yourself by using a wrist grounding strap or by periodically touching an unpainted metal surface (such as a connector on the back of the computer).
- ➡ NOTICE:** Only a certified service technician should perform repairs on your computer. Damage due to servicing that is not authorized by Dell™ is not covered by your warranty.
- ➡ NOTICE:** To help prevent damage to the system board, remove the main battery (see [Before Working Inside Your Computer](#)) before working inside the computer.
- 

### Removing the Coin-Cell Battery

1. Follow the instructions in [Before You Begin](#).
2. Remove the base cover (see [Removing the Base Cover](#)).
3. Disconnect the coin-cell battery cable from the system board connector.
4. Lift the coin-cell battery off the computer base.



1	coin-cell battery cable connector	2	coin-cell battery
---	-----------------------------------	---	-------------------

---

### Replacing the Coin-Cell Battery

1. Replace the coin-cell battery.
  2. Connect the coin-cell battery cable to the system board connector.
  3. Replace the base cover (see [Replacing the Base Cover](#)).
  4. Slide the battery into the battery bay until it clicks into place.
- 

[Back to Contents Page](#)

## Processor

### Dell™ Studio XPS™ 1340 Service Manual

- [Removing the Processor](#)
- [Installing the Processor](#)

- ⚠ CAUTION:** Before working inside your computer, read the safety information that shipped with your computer. For additional safety best practices information, see the Regulatory Compliance Homepage at [www.dell.com/regulatory\\_compliance](http://www.dell.com/regulatory_compliance).
- ➡ **NOTICE:** To avoid electrostatic discharge, ground yourself by using a wrist grounding strap or by periodically touching an unpainted metal surface (such as a connector on the back of the computer).
- ➡ **NOTICE:** To prevent intermittent contact between the ZIF-socket cam screw and the processor when removing or replacing the processor, press to apply slight pressure to the center of the processor while turning the cam screw.
- ➡ **NOTICE:** To avoid damage to the processor, hold the screwdriver so that it is perpendicular to the processor when turning the cam screw.
- ➡ **NOTICE:** Only a certified service technician should perform repairs on your computer. Damage due to servicing that is not authorized by Dell™ is not covered by your warranty.
- ➡ **NOTICE:** To help prevent damage to the system board, remove the main battery (see [Before Working Inside Your Computer](#)) before working inside the computer.
- 

## Removing the Processor

1. Follow the instructions in [Before You Begin](#).
2. Remove the base cover (see [Removing the Base Cover](#)).
3. Remove the rear caps (see [Removing the Rear Caps](#)).
4. Remove the central processor heat sink (see [Removing the Central Processor Heat Sink](#)).

- ➡ **NOTICE:** When removing the processor, pull it straight up. Be careful not to bend the pins on the processor.

5. To loosen the ZIF socket, use a small, flat-blade screwdriver and rotate the ZIF-socket cam screw counterclockwise until it comes to the cam stop. The ZIF-socket cam screw secures the processor to the system board. Take note of the arrow on the ZIF-socket cam screw.

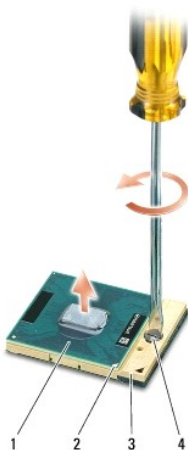

1	processor	2	pin-1 corner of processor	3	ZIF socket
4	ZIF-socket cam screw				

6. Use a processor extraction tool to remove the processor.

---

## Installing the Processor

➡ **NOTICE:** Ensure that the cam lock is in the fully open position before seating the processor. Seating the processor properly in the ZIF socket does not require force.

➡ **NOTICE:** A processor that is not properly seated can result in an intermittent connection or permanent damage to the processor and ZIF socket.

1. Align the pin-1 corner of the processor so that it points to the triangle on the ZIF socket, and insert the processor into the ZIF socket.

When the processor is correctly seated, all four corners are aligned at the same height. If one or more corners of the processor are higher than the others, the processor is not seated correctly.

➡ **NOTICE:** To prevent intermittent contact between the ZIF-socket cam screw and the processor when removing or replacing the processor, press to apply slight pressure to the center of the processor while turning the cam screw.

2. Tighten the ZIF socket by turning the cam screw clockwise to secure the processor to the system board.
3. Peel the backing off the new thermal cooling pads in the kit and adhere the pads to the portions of the processor heat sink that cover the central processor unit and the graphic processor unit.

🔧 **NOTE:** If the processor or system board is replaced, use the thermal cooling pads provided in the kit on the processor heat sinks to ensure that thermal conductivity is achieved. Do not reuse the old thermal cooling pads.

4. Replace the central processor heat sink (see [Replacing the Central Processor Heat Sink](#)).
5. Replace the rear caps (see [Replacing the Rear Caps](#)).
6. Replace the base cover (see [Replacing the Base Cover](#)).
7. Slide the battery into the battery bay until it clicks into place.
8. Update the BIOS using the BIOS upgrade CD. See ([Flashing the BIOS](#)).

---

[Back to Contents Page](#)

## Processor Heat Sink

### Dell™ Studio XPS™ 1340 Service Manual

- [Central Processor Heat Sink](#)
- [Graphic Processor Heat Sink/Thermal Fan](#)

- ⚠ CAUTION:** Before working inside your computer, read the safety information that shipped with your computer. For additional safety best practices information, see the Regulatory Compliance Homepage at [www.dell.com/regulatory\\_compliance](http://www.dell.com/regulatory_compliance).
- 🔧 NOTICE:** To avoid electrostatic discharge, ground yourself by using a wrist grounding strap or by periodically touching an unpainted metal surface (such as a connector on the back of the computer).
- 🔧 NOTICE:** Only a certified service technician should perform repairs on your computer. Damage due to servicing that is not authorized by Dell™ is not covered by your warranty.
- 🔧 NOTICE:** To help prevent damage to the system board, remove the main battery (see [Before Working Inside Your Computer](#)) before working inside the computer.
- 

## Central Processor Heat Sink

### Removing the Central Processor Heat Sink

1. Follow the instructions in [Before You Begin](#).
2. Remove the base cover (see [Removing the Base Cover](#)).
3. Remove the rear caps (see [Removing the Rear Caps](#)).
4. Loosen the four captive screws that secure the central processor heat sink to the system board.

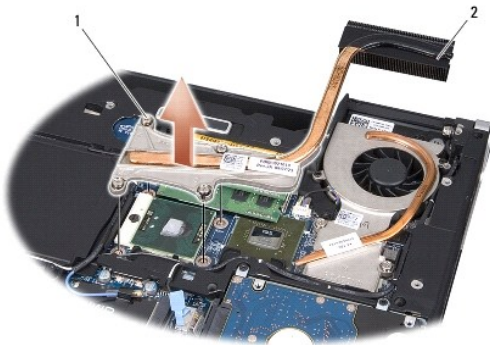

1	captive screws (4)	2	central processor heat sink
---	--------------------	---	-----------------------------

5. Lift the central processor heat sink off the computer.

### Replacing the Central Processor Heat Sink

**🔧 NOTE:** This procedure assumes that you have already removed the central processor heat sink and are ready to replace it.

1. Place the new thermal cooling pad on the central processor heat sink.

**🔧 NOTE:** If the central processor heat sink is replaced, the thermal cooling pad will be attached to the new central processor heat sink.

2. Place the central processor heat sink on the system board.

3. Tighten the four captive screws that secure the central processor heat sink to the system board.
4. Replace the rear caps (see [Replacing the Rear Caps](#)).
5. Replace the base cover (see [Replacing the Base Cover](#)).
6. Slide the battery into the battery bay until it clicks into place.

## Graphic Processor Heat Sink/Thermal Fan

### Removing the Graphic Processor Heat Sink/Thermal Fan

- NOTE: The graphic processor heat sink availability may depend on your system configuration.
- NOTE: The removal procedure for the thermal fan may differ according to your system configuration.

1. Follow the instructions in [Before You Begin](#).
2. Remove the base cover (see [Removing the Base Cover](#)).
3. Remove the rear caps (see [Removing the Rear Caps](#)).
4. Remove the central processor heat sink (see [Removing the Central Processor Heat Sink](#)).
5. Loosen the two captive screws and remove the other two screws that secure the graphic processor heat sink/thermal fan to the system board.
6. Disconnect the thermal fan cable from the system board connector.

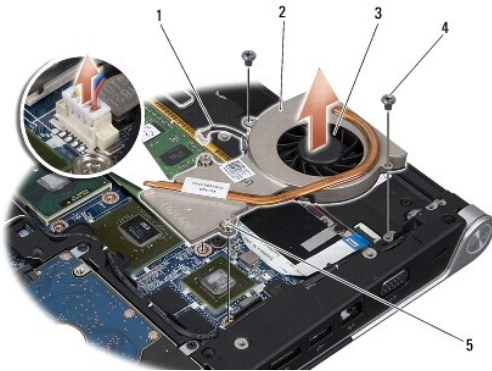

1	fan cable	2	graphic processor heat sink
3	thermal fan	4	screws (2)
5	captive screws (2)		

7. Lift the graphic processor heat sink/thermal fan off the computer.

### Replacing the Graphic Processor Heat Sink/Thermal Fan

- NOTE: This procedure assumes that you have already removed the graphic processor heat sink/thermal fan and are ready to replace it.

1. Place the new thermal cooling pad on the graphic processor heat sink/thermal fan.

- NOTE: If the graphic processor heat sink is replaced, the thermal cooling pad will be attached to the new graphic processor heat sink. Use the thermal cooling pad provided in the kit on the central processor heat sink and graphic processor heat sink.

2. Place the graphic processor heat sink/thermal fan on the system board.

3. Tighten the two captive screws and replace the other two screws that secure the graphic processor heat sink to the system board.
  4. Connect the thermal fan cable to the system board connector.
  5. Replace the central processor heat sink (see [Replacing the Central Processor Heat Sink](#))
  6. Replace the rear caps (see [Replacing the Rear Caps](#)).
  7. Replace the base cover (see [Replacing the Base Cover](#)).
  8. Slide the battery into the battery bay until it clicks into place.
- 

[Back to Contents Page](#)

[Back to Contents Page](#)

## Display Assembly

Dell™ Studio XPS™ 1340 Service Manual

- [Removing the Display Assembly](#)
- [Replacing the Display Assembly](#)

- ⚠ **CAUTION:** Before working inside your computer, read the safety information that shipped with your computer. For additional safety best practices information, see the Regulatory Compliance Homepage at [www.dell.com/regulatory\\_compliance](http://www.dell.com/regulatory_compliance).
  - 🔧 **NOTICE:** To avoid electrostatic discharge, ground yourself by using a wrist grounding strap or by periodically touching an unpainted metal surface (such as a connector on the back of the computer).
  - 🔧 **NOTICE:** Only a certified service technician should perform repairs on your computer. Damage due to servicing that is not authorized by Dell™ is not covered by your warranty.
  - 🔧 **NOTICE:** To help prevent damage to the system board, remove the main battery (see [Before Working Inside Your Computer](#)) before working inside the computer.
  - 🔧 **NOTICE:** To avoid damage to the display, you must not disassemble your Edge-to-Edge display assembly in the field.
- 

### Removing the Display Assembly

1. Follow the instructions in [Before You Begin](#).
2. Remove the palm rest (see [Removing the Palm Rest](#)).
3. Remove the optical drive (see [Removing the Optical Drive](#)).
4. Make note of the Mini-Card cable routing and carefully dislodge the Mini-Card antenna cables from their routing guides.



5. Pull the Mini-Card cables out through the system board so that they are clear of the computer base.
6. Make note of the display cable, power light cable, and camera cable routing.

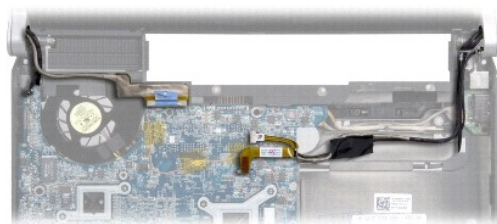

7. Remove the display cable grounding screw that secures the display ground cable to the system board.

8. Disconnect the display cable, power light cable, and camera cable from their system board connectors and dislodge the cables from their routing guides.
9. Remove the four screws (two on either side) that secure the display assembly to the computer base.
10. Lift the display assembly off the computer.

➔ **NOTICE:** To avoid damage to the display, you must not disassemble your Edge-to- Edge display assembly.

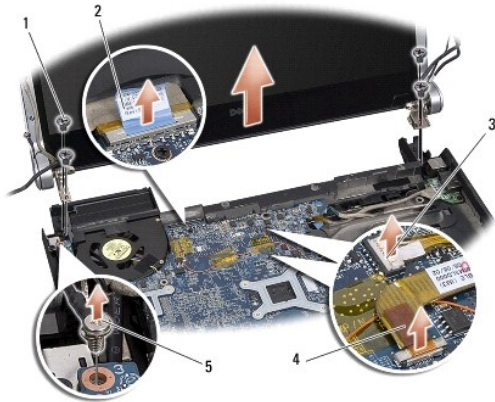

1	screws (total 4; 2 on each side)	2	display cable pull-tab
3	power light cable connector	4	camera cable connector
5	display cable grounding screw		

## Replacing the Display Assembly

➔ **NOTICE:** To avoid damage to the display, you must not disassemble your Edge-to- Edge display assembly.

1. Place the display assembly in position and replace the four screws (two on either side) that secure the display assembly.
2. Replace the display cable grounding screw that secures the display ground cable to the system board.
3. Carefully slide the Mini-Card antenna cables through the system board and into their routing guides.
4. Reconnect the Mini-Card cables to the Mini-Card, if applicable (see [Replacing the Mini-Card](#)).
5. Route the power light cable and camera cable through the routing guides and connect the cables to the respective system board connectors.
6. Replace the optical drive (see [Replacing the Optical Drive](#)).
7. Replace the palm rest (see [Replacing the Palm Rest](#)).

➔ **NOTICE:** Before turning on the computer, replace all screws and ensure that no stray screws remain inside the computer. Failure to do so may result in damage to the computer.

[Back to Contents Page](#)



## eSATA Connector

### Dell™ Studio XPS™ 1340 Service Manual

- [Removing the eSATA Connector](#)
- [Replacing the eSATA Connector](#)

- ⚠ CAUTION:** Before working inside your computer, read the safety information that shipped with your computer. For additional safety best practices information, see the Regulatory Compliance Homepage at [www.dell.com/regulatory\\_compliance](http://www.dell.com/regulatory_compliance).
- ➡ NOTICE:** To avoid electrostatic discharge, ground yourself by using a wrist grounding strap or by periodically touching an unpainted metal surface (such as the back panel) on the computer.
- ➡ NOTICE:** Only a certified service technician should perform repairs on your computer. Damage due to servicing that is not authorized by Dell™ is not covered by your warranty.
- ➡ NOTICE:** To help prevent damage to the system board, remove the main battery (see [Before Working Inside Your Computer](#)) before working inside the computer.
- 

## Removing the eSATA Connector

1. Follow the instructions in [Before Working Inside Your Computer](#).
2. Remove the display assembly (see [Removing the Display Assembly](#)).
3. Remove the system board (see [Removing the System Board](#)).
4. Remove the two screws that secure the eSATA connector.
5. Remove the eSATA cable from the routing guide.
6. Lift the eSATA connector and cable out of the computer base.

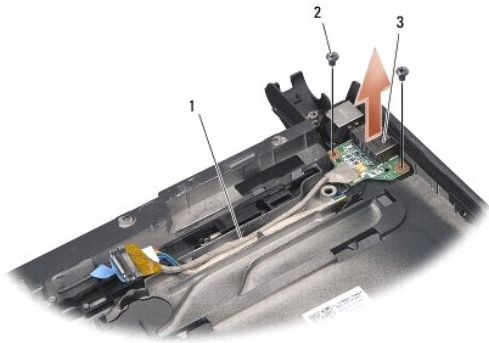

1	cable routing	2	screws (2)
3	eSATA connector		

---

## Replacing the eSATA Connector

1. Place the eSATA connector in the computer base.
2. Replace the two screws that secures the eSATA connector.
3. Route the eSATA cable through the routing guide.
4. Connect the eSATA cable to the system board connector.

 **NOTICE:** Before turning on the computer, replace all screws and ensure that no stray screws remain inside the computer. Failure to do so may result in damage to the computer.

5. Replace the system board (see [Replacing the System Board](#)).
6. Replace the display assembly (see [Replacing the Display Assembly](#)).

---

[Back to Contents Page](#)

## Hard Drive

### Dell™ Studio XPS™ 1340 Service Manual

- [Removing the Hard Drive](#)
- [Replacing the Hard Drive](#)

- ⚠ **CAUTION:** If you remove the hard drive from the computer when the drive is hot, do not touch the metal housing of the hard drive.
- ⚠ **CAUTION:** Before working inside your computer, read the safety information that shipped with your computer. For additional safety best practices information, see the Regulatory Compliance Homepage at [www.dell.com/regulatory\\_compliance](http://www.dell.com/regulatory_compliance).
- ➡ **NOTICE:** To prevent data loss, turn off your computer (see [Turning Off Your Computer](#)) before removing the hard drive. Do not remove the hard drive while the computer is on or in Sleep state.
- ➡ **NOTICE:** Hard drives are extremely fragile. Exercise care when handling the hard drive.
- ➡ **NOTICE:** Only a certified service technician should perform repairs on your computer. Damage due to servicing that is not authorized by Dell is not covered by your warranty.
- ➡ **NOTICE:** To help prevent damage to the system board, remove the main battery (see [Before Working Inside Your Computer](#)) before working inside the computer.
- 📌 **NOTE:** Dell does not guarantee compatibility or provide support for hard drives from sources other than Dell.
- 📌 **NOTE:** If you are installing a hard drive from a source other than Dell, you need to install an operating system, drivers, and utilities on the new hard drive (see the *Dell Technology Guide*).

## Removing the Hard Drive

1. Follow the instructions in [Before You Begin](#).
2. Remove the base cover (see [Removing the Base Cover](#)).
3. Remove the four screws securing the hard drive assembly to the computer base.
4. Pull the blue pull-tab to disconnect the hard drive assembly from the system board connector.
5. Lift the hard drive out of the computer base.

- ➡ **NOTICE:** When the hard drive is not in the computer, store it in protective antistatic packaging (see "Protecting Against Electrostatic Discharge" in the safety instructions that shipped with your computer).

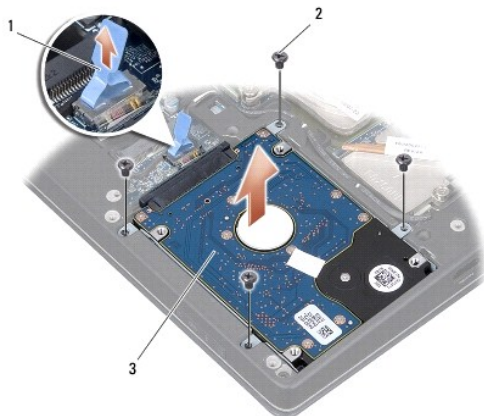

1	blue pull-tab	2	screws (4)
3	hard drive assembly		

6. Pull the interposer to detach it from the hard drive.

7. Remove the four screws that secure the hard drive bracket to the hard drive and remove the bracket.



1	blue pull-tab	2	interposer
3	hard drive bracket	4	screws (4)

---

## Replacing the Hard Drive

1. Remove the new drive from its packaging.

Save the original packaging for storing or shipping the hard drive.

**NOTICE:** Use firm and even pressure to slide the drive into place. If you use excessive force, you may damage the connector.

2. Replace the hard drive bracket and the four screws that secure the bracket to the hard drive.
3. Connect the interposer to the hard drive.
4. Place the hard drive assembly in the computer base.
5. Replace the four screws securing the hard drive assembly to the computer base.
6. Replace the base cover (see [Replacing the Base Cover](#)).

**NOTICE:** Before turning on the computer, replace all screws and ensure that no stray screws remain inside the computer. Failure to do so may result in damage to the computer.

7. Slide the battery into the battery bay until it clicks into place.
8. Install the operating system for your computer, as needed (see *Dell Technology Guide*).
9. Install the drivers and utilities for your computer, as needed (see *Dell Technology Guide*).

---

[Back to Contents Page](#)

## Rear Caps

### Dell™ Studio XPS™ 1340 Service Manual

- [Removing the Rear Caps](#)
- [Replacing the Rear Caps](#)

- ⚠ **CAUTION:** Before working inside your computer, read the safety information that shipped with your computer. For additional safety best practices information, see the Regulatory Compliance Homepage at [www.dell.com/regulatory\\_compliance](http://www.dell.com/regulatory_compliance).
  - ⚠ **CAUTION:** Before performing this procedures, turn off the computer, disconnect the AC adapter from the electrical outlet and the computer, disconnect the modem from the wall connector and the computer, and remove any other external cables from the computer.
  - 👉 **NOTICE:** To avoid electrostatic discharge, ground yourself by using a wrist grounding strap or by periodically touching an unpainted metal surface (such as a connector on the back of the computer).
  - 👉 **NOTICE:** Only a certified service technician should perform repairs on your computer. Damage due to servicing that is not authorized by Dell™ is not covered by your warranty.
  - 👉 **NOTICE:** To help prevent damage to the system board, remove the main battery (see "Before Working Inside Your Computer" on page 10) before working inside the computer.
- 

## Removing the Rear Caps

1. Follow the instructions in [Before You Begin](#).
2. Remove the base cover (see [Removing the Base Cover](#)).
3. Remove the three screws that secure the left and right rear caps to the computer base.
4. Lift the rear caps off the computer base.

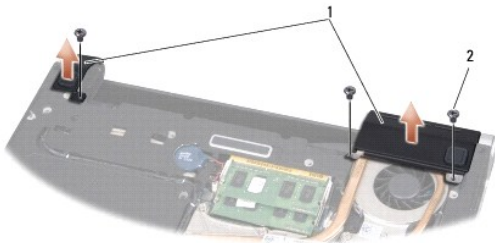

1	rear caps	2	screws (3)
---	-----------	---	------------

---

## Replacing the Rear Caps

1. Replace the rear caps.
  2. Replace the three screws that secure the left and right rear caps to the computer base.
  3. Replace the base cover (see [Replacing the Base Cover](#)).
  4. Slide the battery into the battery bay until it clicks into place.
-

## Keyboard

### Dell™ Studio XPS™ 1340 Service Manual

- [Removing the Keyboard](#)
- [Replacing the Keyboard](#)

- ⚠ CAUTION:** Before working inside your computer, read the safety information that shipped with your computer. For additional safety best practices information, see the Regulatory Compliance Homepage at [www.dell.com/regulatory\\_compliance](http://www.dell.com/regulatory_compliance).
- ➡ NOTICE:** To avoid electrostatic discharge, ground yourself by using a wrist grounding strap or by periodically touching an unpainted metal surface (such as a connector on the back of the computer).
- ➡ NOTICE:** Only a certified service technician should perform repairs on your computer. Damage due to servicing that is not authorized by Dell™ is not covered by your warranty.
- ➡ NOTICE:** To help prevent damage to the system board, remove the main battery (see [Before Working Inside Your Computer](#)) before working inside the computer.
- 

## Removing the Keyboard

1. Follow the instructions in [Before You Begin](#).
  2. Remove the palm rest (see [Removing the Palm Rest](#)).
  3. Turn the palm rest over and remove the ten screws that secure the keyboard to the palm rest.
- ➡ NOTICE:** The keycaps on the keyboard are fragile, easily dislodged, and time-consuming to replace. Be careful when removing and handling the keyboard.
4. Disconnect the multimedia board cable and power board cable from their connectors.
  5. Disconnect the dual multimedia board/power board cable from the connector.
  6. Disconnect the backlit keyboard cable (availability varies according to region) from the connector.
  7. Remove the keyboard shield.
  8. Lift the keyboard out of the palm rest.

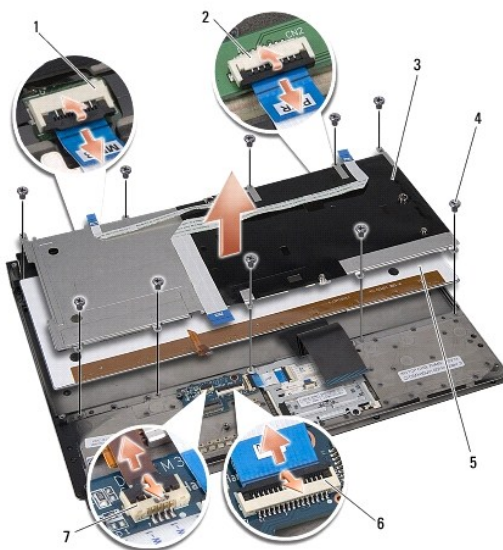

1	multimedia board cable connector	2	power board cable connector
---	----------------------------------	---	-----------------------------

3	keyboard shield	4	screws (10)
5	keyboard	6	dual multimedia board/power board cable connector
7	backlit keyboard cable connector (availability varies according to region)		

---

## Replacing the Keyboard

1. Replace the keyboard on the palm rest.
2. Align the keyboard shield over the screw holes on the palm rest.
3. Replace the ten screws that secure the keyboard and the shield to the palm rest.
4. Connect the backlit keyboard cable (availability varies according to region) to the connector.
5. Connect the multimedia board cable and power board cable to their connectors.
6. Connect the dual multimedia board/power board cable to the connector.

 **NOTICE:** The keycaps on the keyboard are fragile, easily dislodged, and time-consuming to replace. Be careful when removing and handling the keyboard.

7. Replace the palm rest (see [Replacing the Palm Rest](#)).
- 

[Back to Contents Page](#)

## Status Light Board

### Dell™ Studio XPS™ 1340 Service Manual

- [Removing the Status Light Board](#)
- [Replacing the Status Light Board](#)

- ⚠ CAUTION:** Before working inside your computer, read the safety information that shipped with your computer. For additional safety best practices information, see the Regulatory Compliance Homepage at [www.dell.com/regulatory\\_compliance](http://www.dell.com/regulatory_compliance).
- ➡ NOTICE:** To avoid electrostatic discharge, ground yourself by using a wrist grounding strap or by periodically touching an unpainted metal surface (such as a connector on the back of the computer).
- ➡ NOTICE:** Only a certified service technician should perform repairs on your computer. Damage due to servicing that is not authorized by Dell™ is not covered by your warranty.
- ➡ NOTICE:** To help prevent damage to the system board, remove the main battery (see [Before Working Inside Your Computer](#)) before working inside the computer.
- 

## Removing the Status Light Board

1. Follow the instructions in [Before You Begin](#).
2. Remove the palm rest (see [Removing the Palm Rest](#)).
3. Disconnect the status light board cable from the system board connector.
4. Remove the screw that secures the status light board to the computer base.
5. Lift the status light board off the computer.

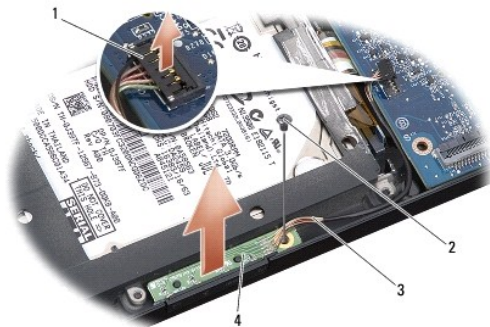

1	system board cable connector	2	screw
3	status light cable	4	status light board

---

## Replacing the Status Light Board

1. Place the status light board on the computer base.
  2. Replace the screw that secures the status light board to the computer base.
  3. Connect the status light cable to the system board connector.
  4. Replace the palm rest (see [Replacing the Palm Rest](#)).
-





## Memory

### Dell™ Studio XPS™ 1340 Service Manual

- [Removing the Memory Module\(s\)](#)
- [Replacing the Memory Module\(s\)](#)

- ⚠ CAUTION:** Before working inside your computer, read the safety information that shipped with your computer. For additional safety best practices information, see the Regulatory Compliance Homepage at [www.dell.com/regulatory\\_compliance](http://www.dell.com/regulatory_compliance).
- ➡ NOTICE:** To avoid electrostatic discharge, ground yourself by using a wrist grounding strap or by periodically touching an unpainted metal surface (such as a connector on the back of the computer).
- ➡ NOTICE:** Only a certified service technician should perform repairs on your computer. Damage due to servicing that is not authorized by Dell™ is not covered by your warranty.
- ➡ NOTICE:** To help prevent damage to the system board, remove the main battery (see [Before Working Inside Your Computer](#)) before working inside the computer.

You can increase your computer memory by installing memory modules on the system board. See "Specifications" in your *Setup Guide* for information on the memory supported by your computer. Install only memory modules that are intended for your computer.

**📌 NOTE:** Memory modules purchased from Dell are covered under your computer warranty.

Your computer has two user-accessible SODIMM sockets that can be accessed from the bottom of the computer. The DIMM B memory module is located directly above the DIMM A memory module located on the bottom of the computer.

- ➡ NOTICE:** If you need to install memory modules in two connectors, install a memory module in the DIMM A connector before you install a module in the DIMM B connector.

---

## Removing the Memory Module(s)

1. Follow the instructions in [Before You Begin](#).
2. Remove the base cover (see [Removing the Base Cover](#)).

- ➡ NOTICE:** To prevent damage to the memory module connector, do not use tools to spread the memory module securing clips.

3. Use your fingertips to carefully spread apart the securing clips on each end of the memory module connector until the module pops up.
4. Remove the module from the connector.

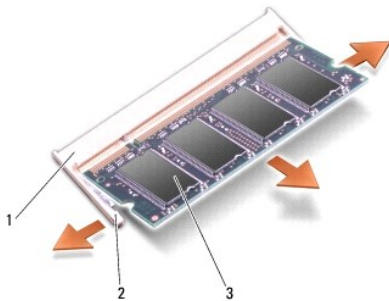

1	memory module connector	2	securing clips (2)
3	memory module		

---

## Replacing the Memory Module(s)

1. Align the notch in the module edge connector with the tab in the connector slot.

- Slide the module firmly into the slot at a 45-degree angle, and press the module down until it clicks into place. If you do not feel the click, remove the module and reinstall it.

 **NOTE:** If the memory module is not installed properly, the computer may not boot.

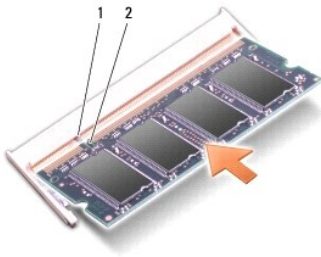

1	tab	2	notch
---	-----	---	-------

 **NOTICE:** If the cover is difficult to close, remove the module and reinstall it. Forcing the cover to close may damage your computer.

- Replace the base cover (see [Replacing the Base Cover](#)).
- Slide the battery into the battery bay, or connect the AC adapter to your computer and an electrical outlet.
- Turn on the computer.

As the computer boots, it detects the additional memory and automatically updates the system configuration information.

To confirm the amount of memory installed in the computer, click **Start**  → **Help and Support** → **Dell System Information**.

---

[Back to Contents Page](#)

## Wireless Mini-Card

### Dell™ Studio XPS™ 1340 Service Manual

- [Removing the Mini-Card](#)
- [Replacing the Mini-Card](#)

- ⚠ **CAUTION:** Before working inside your computer, read the safety information that shipped with your computer. For additional safety best practices information, see the Regulatory Compliance Homepage at [www.dell.com/regulatory\\_compliance](http://www.dell.com/regulatory_compliance).
- 👉 **NOTICE:** To avoid electrostatic discharge, ground yourself by using a wrist grounding strap or by periodically touching an unpainted metal surface (such as the back panel) on the computer.
- 👉 **NOTICE:** Only a certified service technician should perform repairs on your computer. Damage due to servicing that is not authorized by Dell™ is not covered by your warranty.
- 👉 **NOTICE:** To help prevent damage to the system board, remove the main battery (see [Before Working Inside Your Computer](#)) before working inside the computer.
- 📌 **NOTE:** Dell does not guarantee compatibility or provide support for Mini-Cards from sources other than Dell.

If you ordered a wireless Mini-Card with your computer, the card is already installed.

Your computer has three Mini-Card slots:

- 1 two Full Mini-Card slots
- 1 one Half Mini-Card slot

The types of Mini-Cards supported are:

- 1 Wireless Local Area Network (WLAN) — Half Mini-Card
- 1 Mobile broadband or Wireless Wide Area Network (WWAN) — Full Mini-Card
- 1 Wireless Personal Area Network (WPAN) or Internal Card with Bluetooth® Wireless Technology — Full Mini-Card

- 📌 **NOTE:** Your computer can only support two Full Mini-Cards and one Half Mini-Card at a time.
- 📌 **NOTE:** The WLAN slot supports a half Mini-Card.
- 📌 **NOTE:** Depending on the configuration of the system when it was sold, one or more of the Mini-Card slots may not have Mini-Cards installed in them.

---

## Removing the Mini-Card

1. Follow the instructions in [Before You Begin](#).
2. Remove the base cover (see [Removing the Base Cover](#)).
3. Disconnect the antenna cables from the Mini-Card.

- 📌 **NOTE:** If you are removing a WPAN Mini-Card, disconnect the blue antenna cable from the Mini-Card.

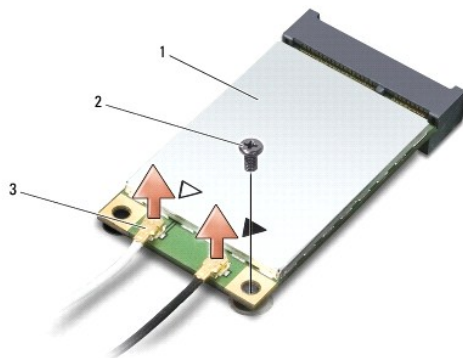

1	Mini-Card	2	screw	3	antenna cable connectors (2)
---	-----------	---	-------	---	------------------------------

4. Remove the screw that secures the Mini-Card to the system board.
5. Lift the Mini-Card out of the system board connector.

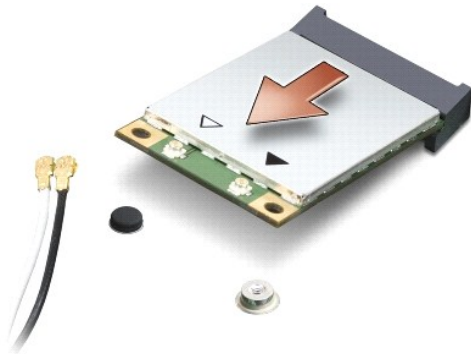

**NOTICE:** When the Mini-Card is not in the computer, store it in protective antistatic packaging. For more information, see "Protecting Against Electrostatic Discharge" in the safety information that shipped with your computer.

## Replacing the Mini-Card

1. Remove the new Mini-Card from its packaging.

**NOTICE:** Use firm and even pressure to slide the card into place. If you use excessive force, you may damage the connector.

2. Insert the Mini-Card connector at a 45-degree angle into the appropriate system board connector. For example, the WLAN card connector is labeled WLAN and so on.
3. Press the other end of the Mini-Card down into the slot on the system board.
4. Replace the securing screw.
5. Connect the appropriate antenna cables to the Mini-Card you are installing. The following table provides the antenna cable color scheme for the Mini-Card supported by your computer.

Connectors on the Mini-Card	Antenna Cable Color Scheme
<b>WWAN (2 antenna cables)</b>	
Main WWAN (white triangle)	white with gray stripe
Auxiliary WWAN (black triangle)	black with gray stripe
<b>WLAN (2 antenna cables)</b>	
Main WLAN (white triangle)	white
Auxiliary WLAN (black triangle)	black
<b>WPAN (one antenna cable)</b>	
WPAN	blue

6. Secure the unused antenna cables in the protective mylar sleeve.
7. Replace the base cover (see [Replacing the Base Cover](#)).
8. Slide the battery into the battery bay until it clicks into place.
9. Install the drivers and utilities for your computer, as required. For more information, see the *Dell Technology Guide*.

**NOTE:** If you are installing a communication card from a source other than Dell, you must install the appropriate drivers and utilities. For more generic driver information, see the *Dell Technology Guide*.

[Back to Contents Page](#)

[Back to Contents Page](#)

## Optical Drive

### Dell™ Studio XPS™ 1340 Service Manual

- [Removing the Optical Drive](#)
- [Replacing the Optical Drive](#)

- ⚠ CAUTION:** Before working inside your computer, read the safety information that shipped with your computer. For additional safety best practices information, see the Regulatory Compliance Homepage at [www.dell.com/regulatory\\_compliance](http://www.dell.com/regulatory_compliance).
- ➡ NOTICE:** To avoid electrostatic discharge, ground yourself by using a wrist grounding strap or by periodically touching an unpainted metal surface (such as the back panel) on the computer.
- ➡ NOTICE:** Only a certified service technician should perform repairs on your computer. Damage due to servicing that is not authorized by Dell™ is not covered by your warranty.
- ➡ NOTICE:** To help prevent damage to the system board, remove the main battery (see [Before Working Inside Your Computer](#)) before working inside the computer.
- 

## Removing the Optical Drive

1. Follow the instructions in [Before You Begin](#).
2. Remove the palm rest (see [Removing the Palm Rest](#)).
3. Turn the computer over and remove the screw that secures the optical drive to the computer base.



4. Turn the computer over and remove the two screws that secure the optical drive to the system board.



1	screws (2)	2	optical drive
3	interposer		

5. Lift the optical drive off the computer.



6. Detach the interposer from the optical drive.
- 

## Replacing the Optical Drive

1. Attach the interposer to the optical drive.
  2. Place the optical drive in the computer base.
  3. Replace the two screws that secure the optical drive to the system board.
  4. Turn the computer over and replace the screw that secures the optical drive to the computer base.
  5. Replace the palm rest (see [Replacing the Palm Rest](#)).
- 

[Back to Contents Page](#)



[Back to Contents Page](#)

## Palm Rest

### Dell™ Studio XPS™ 1340 Service Manual

- [Removing the Palm Rest](#)
- [Replacing the Palm Rest](#)

- ⚠ CAUTION:** Before working inside your computer, read the safety information that shipped with your computer. For additional safety best practices information, see the Regulatory Compliance Homepage at [www.dell.com/regulatory\\_compliance](http://www.dell.com/regulatory_compliance).
- ➡ NOTICE:** To avoid electrostatic discharge, ground yourself by using a wrist grounding strap or by periodically touching an unpainted metal surface (such as the back panel) on the computer.
- ➡ NOTICE:** Only a certified service technician should perform repairs on your computer. Damage due to servicing that is not authorized by Dell™ is not covered by your warranty.
- ➡ NOTICE:** To help prevent damage to the system board, remove the main battery (see [Before Working Inside Your Computer](#)) before working inside the computer.
- 

## Removing the Palm Rest

1. Follow the instructions in [Before You Begin](#).
2. Remove base cover (see [Removing the Base Cover](#)).
3. Remove the rear caps (see [Removing the Rear Caps](#)).
4. Remove the fifteen screws from the computer base.



5. Turn the computer over.



1	keyboard cable connector	2	daughter board cable connector
3	palm rest		

6. Starting at the back center of the palm rest, use your fingers to gently ease the palm rest from the computer base by lifting the inside of the palm rest while pulling on the outside.
7. Disconnect the daughter board cable and keyboard cable from the respective system board connectors.

**NOTICE:** Carefully separate the palm rest from the computer base to avoid damage to the palm rest.

8. Lift the palm rest off the computer base.

## Replacing the Palm Rest

1. Align the palm rest with the computer base.
2. Connect the daughter board cable and keyboard cable to their respective system board connectors and gently snap the palm rest into place.
3. Turn the computer upside down and replace the fifteen screws in the computer base.
4. Replace the rear caps (see [Replacing the Rear Caps](#)).
5. Replace the base cover (see [Replacing the Base Cover](#)).
6. Slide the battery into the battery bay until it clicks into place.

[Back to Contents Page](#)

[Back to Contents Page](#)

## AC Adapter Connector

Dell™ Studio XPS™ 1340 Service Manual

- [Removing the AC Adapter Connector](#)
- [Replacing the AC Adapter Connector](#)

- ⚠ CAUTION:** Before working inside your computer, read the safety information that shipped with your computer. For additional safety best practices information, see the Regulatory Compliance Homepage at [www.dell.com/regulatory\\_compliance](http://www.dell.com/regulatory_compliance).
- ➡ NOTICE:** To avoid electrostatic discharge, ground yourself by using a wrist grounding strap or by periodically touching an unpainted metal surface (such as the back panel) on the computer.
- ➡ NOTICE:** Only a certified service technician should perform repairs on your computer. Damage due to servicing that is not authorized by Dell™ is not covered by your warranty.
- ➡ NOTICE:** To help prevent damage to the system board, remove the main battery (see [Before Working Inside Your Computer](#)) before working inside the computer.
- 

### Removing the AC Adapter Connector

1. Follow the instructions in [Before You Begin](#).
2. Remove the eSATA connector (see [Removing the eSATA Connector](#)).
3. Remove the screw that secures the AC adapter connector.
4. Remove the AC adapter cable from the routing guide.
5. Lift the AC adaptor connector and cable out of the computer base.

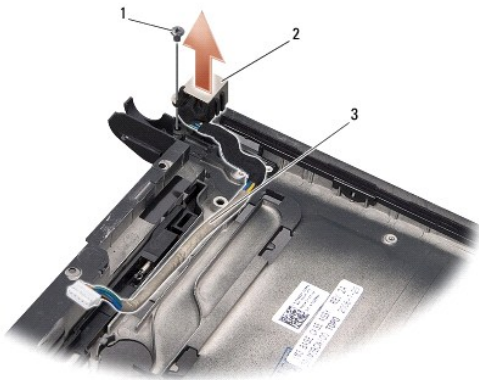

1	screw	2	AC adaptor connector
3	cable routing		

---

### Replacing the AC Adapter Connector

1. Place the AC adapter connector in the computer base.
  2. Replace the screw that secures the AC adapter connector.
  3. Route the AC adapter cable through the routing guide.
- ➡ NOTICE:** Before turning on the computer, replace all screws and ensure that no stray screws remain inside the computer. Failure to do so may result in damage to the computer.

4. Replace the eSATA connector (see [Replacing the eSATA Connector](#)).

---





[Back to Contents Page](#)

[Back to Contents Page](#)

## System Board

### Dell™ Studio XPS™ 1340 Service Manual

- [Removing the System Board](#)
- [Replacing the System Board](#)

-  **CAUTION:** Before working inside your computer, read the safety information that shipped with your computer. For additional safety best practices information, see the Regulatory Compliance Homepage at [www.dell.com/regulatory\\_compliance](http://www.dell.com/regulatory_compliance).
-  **NOTICE:** To avoid electrostatic discharge, ground yourself by using a wrist grounding strap or by periodically touching an unpainted metal surface (such as the back panel) on the computer.
-  **NOTICE:** Only a certified service technician should perform repairs on your computer. Damage due to servicing that is not authorized by Dell™ is not covered by your warranty.
-  **NOTICE:** To help prevent damage to the system board, remove the main battery (see [Before Working Inside Your Computer](#)) before working inside the computer.

The system board's BIOS chip contains the Service Tag, which is also visible on a barcode label on the bottom of the computer. The replacement kit for the system board includes a CD that provides a utility for transferring the Service Tag to the replacement system board.

-  **NOTICE:** Handle components and cards by their edges, and avoid touching pins and contacts.
- 

## Removing the System Board

1. Follow the instructions in [Before You Begin](#).
2. Remove the base cover (see [Removing the Base Cover](#)).
3. Remove the coin-cell battery (see [Removing the Coin-Cell Battery](#)).
4. Remove the hard drive (see [Removing the Hard Drive](#)).
5. Remove the memory modules (see [Removing the Memory Module\(s\)](#)).
6. Remove the rear caps (see [Removing the Rear Caps](#)).
7. Remove the processor heat sinks (see [Removing the Central Processor Heat Sink](#) and [Removing the Graphic Processor Heat Sink/Thermal Fan](#)).
8. Remove the Mini-Cards, if any (see [Removing the Mini-Card](#)).
9. Remove the palm rest (see [Removing the Palm Rest](#)).
10. Remove the optical drive (see [Removing the Optical Drive](#)).
11. Remove the seven screws that secure the system board to the computer base.
12. Remove the display cable grounding screw that secures the display ground cable to the system board.

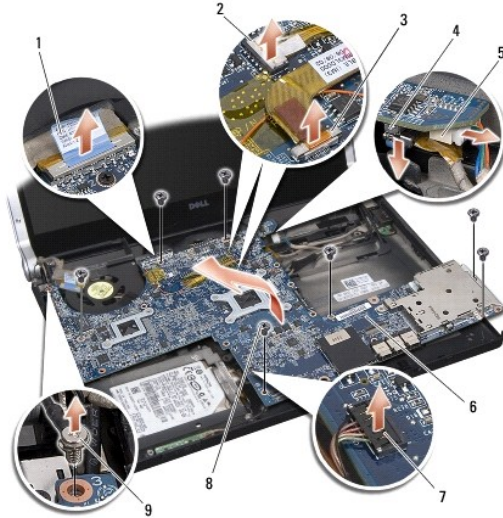

1 display cable pull-tab	2 power light cable connector
3 camera cable connector	4 eSATA cable connector
5 AC adapter cable connector	6 system board
7 status light board cable connector	8 screws (7)
9 display cable grounding screw	

13. Disconnect the display cable, power light cable, camera cable, and status light board cable from the system board connector.
14. Lift the system board at an angle towards the side of the computer and disconnect the eSATA cable and AC adapter cable from the system board.
15. Lift the system board out of the computer base.

## Replacing the System Board

1. Place the system board in the computer base at an angle.
  2. Connect the eSATA cable and the AC adapter cable to the system board and place the system board in position.
  3. Replace the seven screws that secure the system board to the computer base.
  4. Connect the display cable, power light cable, camera cable, and status light board cable to the system board connector.
  5. Replace the display cable grounding screw that secures the display ground cable to the system board.
  6. Replace the optical drive (see [Replacing the Optical Drive](#)).
  7. Replace the palm rest (see [Replacing the Palm Rest](#)).
  8. Replace the Mini-Cards, if any (see [Replacing the Mini-Card](#)).
  9. Place the new thermal cooling pads on the processor heat sinks.
- NOTE:** If the processor or system board is replaced, use the thermal cooling pad provided in the kit on the central processor heat sink and graphic processor heat sink to ensure that thermal conductivity is achieved.
10. Replace the processor heat sinks (see [Replacing the Central Processor Heat Sink](#) and [Replacing the Graphic Processor Heat Sink/Thermal Fan](#)).
  11. Replace the rear caps (see [Replacing the Rear Caps](#)).
  12. Replace the memory modules, if any (see [Replacing the Memory Module\(s\)](#)).
  13. Replace the hard drive (see [Replacing the Hard Drive](#)).

14. Replace the coin-cell battery (see [Replacing the Coin-Cell Battery](#)).

15. Replace the base cover (see [Replacing the Base Cover](#)).

 **NOTICE:** Before turning on the computer, replace all screws and ensure that no stray screws remain inside the computer. Failure to do so may result in damage to the computer.

16. Turn on the computer.

 **NOTE:** After you have replaced the system board, enter the computer Service Tag into the BIOS of the replacement system board.

17. Insert the BIOS upgrade CD that accompanied the replacement system board into the appropriate drive. Follow the instructions that appear on the screen.

---

[Back to Contents Page](#)